

SCADENZA 31 LUGLIO 2024



Dal 6 all' 8
MARZO 2024



ITALIANO

OFFERTA SPECIALE

www.gerardi.it

TAVOLE A CAMBIO RAPIDO
Riduci i tempi di inattività e accelera la tua produzione

NOVITÀ 2024! RICHIEDI MAGGIORI INFORMAZIONI

STOZZATORE MODULARE

Potenzia ed Aggiorna il tuo Tornio!

Realizza Scanalature e Cave Interne direttamente Sul Tornio



Vai alla Brochure



Morse COMPACT GRIP

Morsa autocentrante con ganasce reversibili - Ideale per centri a 5 assi

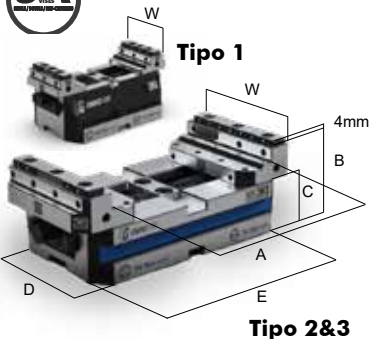
Art.650

Dot. standard: 1 Chiave a pipa, 1 Perno Calibrato, 2 tasselli di posizionamento e 2 tasselli per regolazione autocentrante, 2 inserti Art. 650T G11 passo 11 mm

+ Arresto laterale magnetico Art. 370EM

Tipo	Larghezza ganascia W	Apertura massima A	Altezza morsa B	Altezza corpo C	Larghezza base D	Lunghezza base E	Kg	Cod.	PREZZO LISTINO €	PREZZO OFFERTA €
1 12kN	50	54	65	45	79,9	80	1,9	7.65.01080	777	649
		94				120	2,7	7.65.01120	897	749
		134				160	3,4	7.65.01160	1.015	849
2 22kN	88	96	65	38	89,9	120	3,6	7.65.02120	955	749
		136				160	4,4	7.65.02160	1.075	849
		176				200	5,2	7.65.02200	1.194	949
		216				240	5,8	7.65.02240	1.314	1.049
		216				160	9,1	7.65.03160	1.552	1.249
3 32kN	123	183	89	57	124,9	210	10,9	7.65.03210	1.790	1.349
		233				260	12,8	7.65.03260	2.029	1.449
		283				310	14,8	7.65.03310	2.387	1.749
		283				360	17	7.65.03360	2.625	1.949
		333								

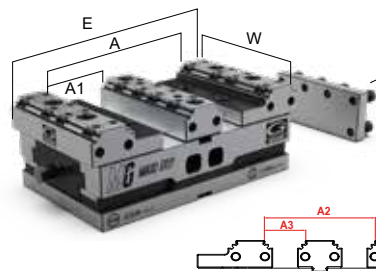
MAXIGRIP

Art.685

Morsa MaxiGrip - 3 Serraggi in 1 - Autocentrante, doppia e singola

Tipo	kN	A	A1	A2	A3	W	E	Kg	Cod.	PREZZO LISTINO €	PREZZO OFFERTA €
4x270	41	200	83	104	35	158	270	28,5	76854270	2.920	2.299
4x420		344	155	248	107	420	40	76854420	3.870	3.099	

Art.684

Morsa MaxiGrip - Solo Autocentrante

Tipo	kN	A	A1	A2	A3	W	E	Kg	Cod.	PREZZO LISTINO €	PREZZO OFFERTA €
4x270	41	200	-	104	-	158	270	25	76844270	2.500	1.999
4x420		344	-	248	-	420	36	76844420	3.450	2.799	

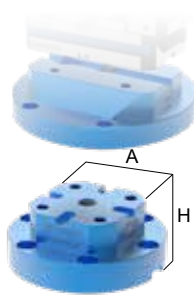
RIALZI PER MORSE COMPACT GRIP
Art.651H

Tipo	Ingombro base A	H=50			H=75			H=100		
		Cod.	PREZZO LISTINO €	PREZZO OFFERTA €	Cod.	PREZZO LISTINO €	PREZZO OFFERTA €	Cod.	PREZZO LISTINO €	PREZZO OFFERTA €
1	80	7.65.1H1080/050	414	350	7.65.1H1080/075	425	350	7.65.1H1080/100	437	350
	120	7.65.1H1120/050	492	400	7.65.1H1120/075	517	400	7.65.1H1120/100	539	400
	160	7.65.1H1160/050	588	450	7.65.1H1160/075	620	500	7.65.1H1160/100	654	500
2	120	7.65.1H2120/050	588	450	7.65.1H2120/075	620	500	7.65.1H2120/100	654	500
	160	7.65.1H2160/050	588	500	7.65.1H2160/075	620	550	7.65.1H2160/100	654	550
	200	7.65.1H2200/050	588	550	7.65.1H2200/075	620	600	7.65.1H2200/100	654	600
	240	7.65.1H2240/050	727	600	7.65.1H2240/075	773	600	7.65.1H2240/100	820	650
3	160	7.65.1H3160/050	680	650	7.65.1H3160/075	726	650	7.65.1H3160/100	769	650
	210	7.65.1H3210/050	680	650	7.65.1H3210/075	726	700	7.65.1H3210/100	769	700
	260	7.65.1H3260/050	1.047	950	7.65.1H3260/075	1.106	950	7.65.1H3260/100	1.167	950
	310	7.65.1H3310/050	1.085	1.000	7.65.1H3310/075	1.146	1.000	7.65.1H3310/100	1.207	1.000
	360	7.65.1H3360/050	1.255	1.100	7.65.1H3360/075	1.326	1.100	7.65.1H3360/100	1.398	1.100

SUPPORTO PIRAMIDALE SPECIFICO PER CENTRI DI LAVORO A 5 ASSI - MORSE INCLUSE
Art.643H

Dotazione standard: 12 Staffe di ancoraggio Art.298 CGR, 1 Golfare, 1 Perno di centraggio, Coppia di tasselli Art.297

+ MONTAGGIO & ALLINEAMENTO INCLUSO

Supporto piramidale in alluminio, consente di montare contemporaneamente 3 morsa CompactGrip con o senza tavolette inclinate di 45° o 60° incrementando così lo spazio di lavoro e permettendo lavorazioni anche di più particolari contemporaneamente anche in punti normalmente difficili da raggiungere.

Type	Altezza	Cod.	PREZZO LISTINO €
1 (Ø200)	170	7.64.3H100	1.763
2 (Ø308)	136	7.64.3H200	2.157
3 (Ø360)	190	7.64.3H300	2.314

KIT 1

Art. 643H + N°3 Art.650 T.1x120



Cod.	PREZZO LISTINO €	PREZZO OFFERTA €
7.65.01120	4.373	3.400

KIT 2

Art. 643H + N°3 Art.650 T.2x200



* Verificare voltaggio tavola macchina

Cod.	PREZZO LISTINO €	PREZZO OFFERTA €
7.65.02200	5.571	4.200

KIT 3

Art. 643H + N°3 Art.650 T.3x210



* Verificare voltaggio tavola macchina

Cod.	PREZZO LISTINO €	PREZZO OFFERTA €
7.65.03210	7.525	5.300



SCANNERIZZA
PER VEDERE
IL VIDEO DI
PRESENTAZIONE



Piastre a CAMBIO RAPIDO

Piastre a cambio rapido meccanico per morse compact grip - Ideali per centri a 5 assi

* NON DISPONIBILI PER IL MERCATO TEDESCO E AUSTRIACO

Art.660

Tavola cambio rapido rettangolare

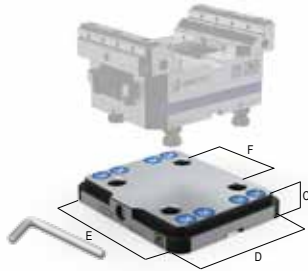

Dotazione standard: 4 Tiranti Art.660B

Tipo	C	D	E	Kg	Cod.	PREZZO LISTINO €	PREZZO OFFERTA €
1-2 (F=52)	27	116	150	3	9.66.05200	787	649
3 (F=96)	27	156	190	5,2	9.66.09600	1.133	949

Art.661

Tavola cambio rapido tonda

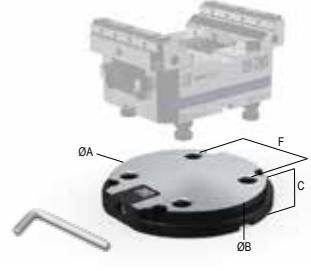

Dotazione standard: 4 Tiranti Art.660B

Tipo	ØA	ØB	C	Kg	Cod.	PREZZO LISTINO €	PREZZO OFFERTA €
1-2 (F=52)	156	120	27	3	9.66.15200	754	649
3 (F=96)	196	175	27	5,2	9.66.19600	1.102	949

Art.660S

Tavola cambio rapido rettangolare
temprata con parte lavorabile
senza fori

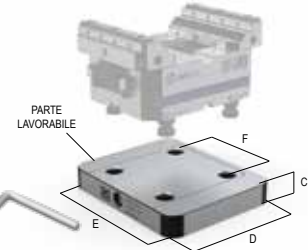

Personalizzazione esclusa

Dotazione standard: 4 Tiranti Art.660B

Tipo	C	D	E	Kg	Cod.	PREZZO LISTINO €	PREZZO OFFERTA €
1-2 (F=52)	27	126	150	3	9.66.0S520	638	549
3 (F=96)	27	156	190	5,2	9.66.0S960	870	749

Art.661S

Tavola cambio rapido tonda
temprata con parte lavorabile
senza fori

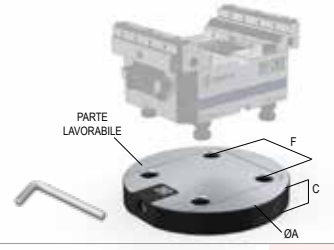

Disponibili modelli per qualsiasi
tavola girevole a 4° asse

Personalizzazione esclusa

Dotazione standard: 4 Tiranti Art.660B

Tipo	ØA	C	Kg	Cod.	PREZZO LISTINO €	PREZZO OFFERTA €
1-2 (F=52)	156	27	3,8	9.66.1S5200	696	549
3 (F=96)	196	27	6	9.66.1S9600	1.159	749
	250	24	10	9.66.1S960-250	1.647	1.550
	300	24	15	9.66.1S960-300	1.750	1.650

Art.660R

Riduzione rettangolare

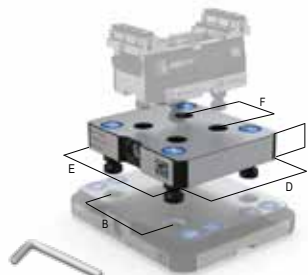

Dotazione standard: 4 Tiranti Art.660B

Tipo	B	C	D	E	Kg	Cod.	PREZZO LISTINO €	PREZZO OFFERTA €
F = 52	96	27	126	150	3,75	9.66.0R210	696	549

Art.661R

Riduzione tonda

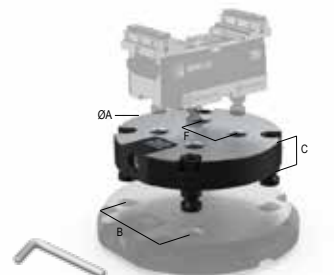

Dotazione standard: 4 Tiranti Art.660B

Tipo	A	B	C	Kg	Cod.	PREZZO LISTINO €	PREZZO OFFERTA €
F = 52	158	96	27	3,75	9.66.1R210	870	549

Art.660B

Tiranti per tavola
a cambio rapido



Per tavole
di tipo 1-2

Per tavole
di tipo 3

Tipo	Cod.	PREZZO LISTINO CAD. €
1 - 2	9.66.0B100	31
3	9.66.0B200	33

Art.661H

Rialzo base
in alluminio
per tavola
cambio rapido,
possibilità di
montaggio con
staffe o tramite
Zero Point



Art.661S



Tavola girevole
Haas Hrt200

Tiranti
Art.660B

Autocentrante

Piastra interfaccia
Art.62B

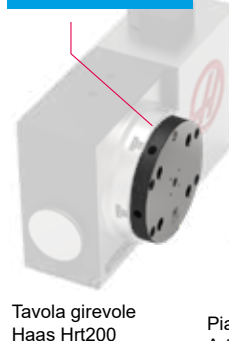
ESEMPIO di
montaggio tavola
a cambio rapido
tonda per
morse
CompactGrip

Morsa
CompactGrip
Art.650 T.3

Morse STANDARD FLEX

Geniale sistema a pettine per la rapida sostituzione delle piastre ganasce - Ideale per centri verticali

Art.1A

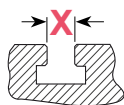

Dot. standard: 1 Arresto laterale, 2 tasselli di posizionamento per cava 16mm, 2 Tappi, 1 Chiave a pipa, 1 Chiave a "T"

+ 4 Staffe Art.298

Morsa modulare di precisione serie StandardFLEX

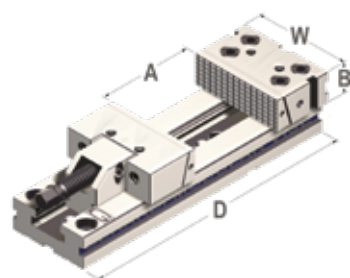

Tipo	Apertura massima A	Larghezza ganasce W	Altezza ganasce B	Lunghezza base D	Cod.	PREZZO LISTINO €	PREZZO OFFERTA €
2 25kN	150	121 mm	38	345	1.1A.20000	925	789
	200	146 mm	48	420	1.1A.32000	1.112	839
3 30kN	300	171 mm	58	520	1.1A.33000	1.283	949
	200	146 mm	48	455	1.1A.42000	1.414	1.189
4 30kN	300	171 mm	58	555	1.1A.43000	1.555	1.239
	400	196 mm	63	655	1.1A.44000	1.696	1.339
5 40kN	200	146 mm	48	495	1.1A.52000	1.846	1.489
	300	171 mm	58	595	1.1A.53000	2.210	1.789
	400	196 mm	63	695	1.1A.54000	2.582	2.039

RISPARMI IL 20%

* Solo se acquistate con la morsa



Morse EXTRA LUNGHE

Le morse XL hanno la base molto più lunga delle normali morse standard - Ideali per centri verticali

Art.21

(Serraggio Singolo)

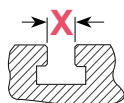

Dot. standard: 1 Arresto laterale, 2 tasselli di posizionamento per cava 16mm, 1 Chiave a pipa, 1 Chiave a "T"

+ 6 Staffe Art.298

Morsa serie XL con dotazione standard

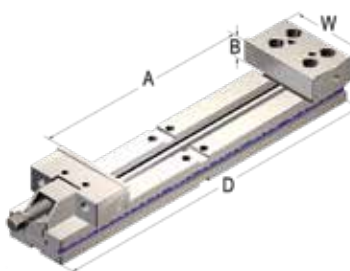

Tipo	Apertura massima A	Larghezza ganasce W	Altezza ganasce B	Lunghezza base D	Kg	Cod.	PREZZO LISTINO €	PREZZO OFFERTA €
2 25kN	320	125 mm	40	520	17	2.21.23200	1.147	800
	360	150 mm	50	580	32	2.21.33600	1.425	1.000
3 30kN	460	175 mm	60	680	35	2.21.34600	1.578	1.150
	500	196 mm	63	766	52	2.21.45000	1.828	1.350
4 30kN	600	175 mm	60	866	56	2.21.46000	1.990	1.450
	700	196 mm	63	966	61	2.21.47000	2.159	1.550

RISPARMI IL 20%

* Solo se acquistate con la morsa



Parallele MAGNETICHE

Ampia gamma di altezze disponibili a pag.4.27 - Listino generale w17

RISPARMI FINO AL 40%

PER MORSE STANDARD & STANDARDFLEX ART.1 E ART.1A

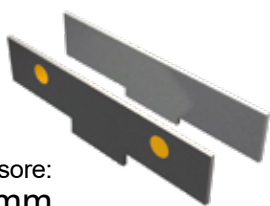

Spessore:
2,8mm

Art.414

Disponibili anche Parallele Magnetiche Universali

Tipo	Coppia di parallele magnetiche guidate PREZZO LISTINO €	Art.310		Art.311	
		Prezzo Cad. se acquistate con set PREZZO CAD €	6 coppie di parallele (Art.313-313R) PREZZO KIT €	Prezzo Cad. se acquistate con set PREZZO CAD €	10 coppie di parallele (Art.313-313R) PREZZO KIT €
1	73	50	300	-	-
2	93	65	390	-	-
3	116	75	450	70	700
4	136	90	540	80	800
5	155	100	600	90	900
6	176	120	720	100	1.000





Kit di AUTOMAZIONE

Centraline con comando pneumatico e cilindro a singolo effetto - Ideale per centri verticali

PER MORSE STANDARD & STANDARDFLEX ART.1 E ART.1A

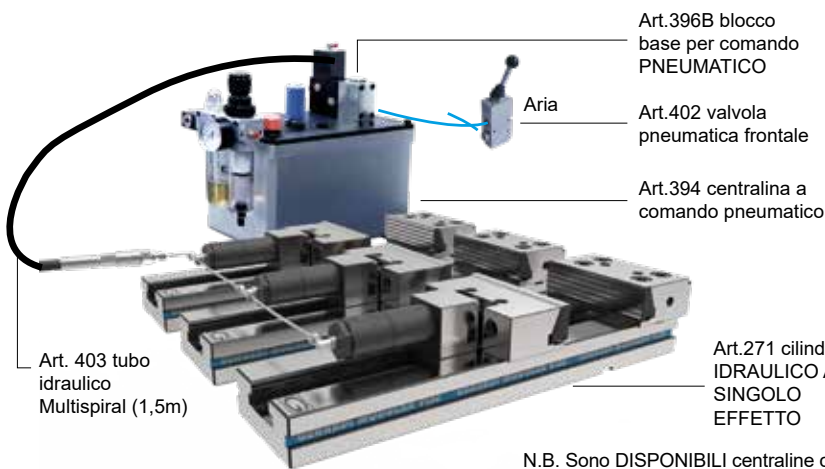

Art.396B blocco base per comando PNEUMATICO
Aria
Art.402 valvola pneumatica frontale
Art.394 centralina a comando pneumatico

Art. 403 tubo idraulico Multispiral (1,5m)

Art.271 cilindro IDRAULICO A SINGOLO EFFETTO

N.B. Sono DISPONIBILI centraline con elettrovalvole per PER CNC

MORSA NON INCLUSA

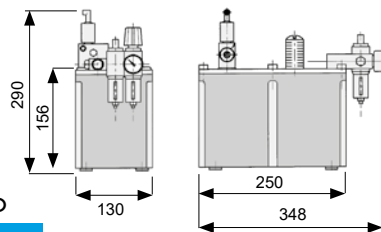

N°1 SERRAGGIO

Art.392

Tipo	Corsa Pistone Art.271	Cod.	PREZZO LISTINO €	PREZZO OFFERTA €
2	26	4.39.22000	1.872	1.499
3		4.39.23000	1.884	1.499
4	40	4.39.24000	1.917	1.499
5		4.39.25000	2.109	1.599

KIT DI SERRAGGIO SIMULTANEO DI PIÙ MORSE

Art.392/2

(Art.271- 394 - 402 - 403)
N°2 SERRAGGI SIMULTANEI
Art.392 + N°1 Art.271

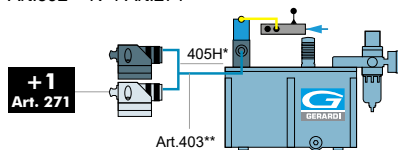

Tipo	Cod.	PREZZO LISTINO €	PREZZO OFFERTA €
2	4.39.22002	2.255	1.799
3	4.39.23002	2.277	1.799
4	4.39.24002	2.345	1.799
5	4.39.25002	2.725	2.099

Art.392/3

N°3 SERRAGGI SIMULTANEI
Art.392 + N°2 Art.271

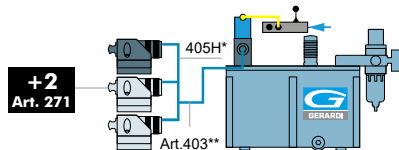

Tipo	Cod.	PREZZO LISTINO €	PREZZO OFFERTA €
2	4.39.22003	2.634	2.099
3	4.39.23003	2.667	2.099
4	4.39.24003	2.767	2.099
5	4.39.25003	3.341	2.499

Art.392/4

N°4 SERRAGGI SIMULTANEI
Art.392 + N°3 Art.271

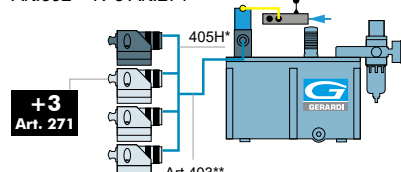

Tipo	Cod.	PREZZO LISTINO €	PREZZO OFFERTA €
2	4.39.22004	3.017	2.399
3	4.39.23004	3.059	2.399
4	4.39.24004	3.196	2.399
5	4.39.25004	3.958	2.999

*Art.405H Tubo in acciaio zincato Ø6 (m1,0) (Non compreso) Codice: 4.40.5H000

KIT DI SERRAGGIO INDIPENDENTE DI PIÙ MORSE

Art.392A/2

(Art.271- 394 - 402 - 403)
N°2 SERRAGGI INDIPENDENTI
Art.392 + N°1 Art.407B

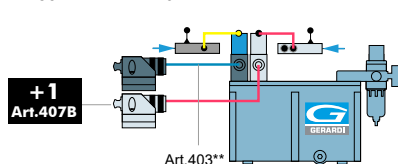

Tipo	Cod.	PREZZO LISTINO €	PREZZO OFFERTA €
2	4.39.2A202	3.063	2.399
3	4.39.2A302	3.083	2.399
4	4.39.2A402	3.161	2.399
5	4.39.2A502	3.639	2.799

Art.392A/3

N°3 SERRAGGI INDIPENDENTI
Art.392 + N°2 Art.407B

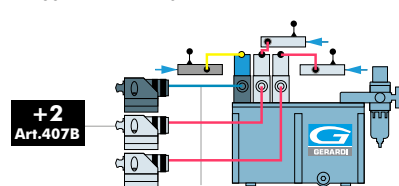

Tipo	Cod.	PREZZO LISTINO €	PREZZO OFFERTA €
2	4.39.2A203	3.564	2.799
3	4.39.2A303	3.596	2.799
4	4.39.2A403	3.695	2.799
5	4.39.2A503	4.247	3.299

Art.392A/4

N°4 SERRAGGI INDIPENDENTI
Art.392 + N°3 Art.407B

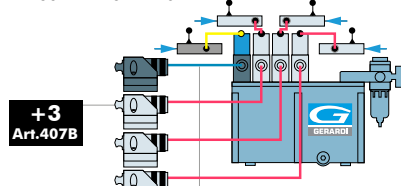

Tipo	Cod.	PREZZO LISTINO €	PREZZO OFFERTA €
2	4.39.2A204	4.413	3.599
3	4.39.2A304	4.455	3.599
4	4.39.2A404	4.584	3.599
5	4.39.2A504	5.319	4.199

*Art.403 (Compreso) Tubo idraulico Multispiral 760bar completo di attacco rapido Art. 270A (m 1,5) Codice: 4.40.30000

Morse FMS

Per serraggi singoli, doppi e autocentranti - Ideali per centri verticali e ed orizzontali

Art.855

Corpo Base 3 in 1

Art.855A

Corpo Base
Solo Autocentrante

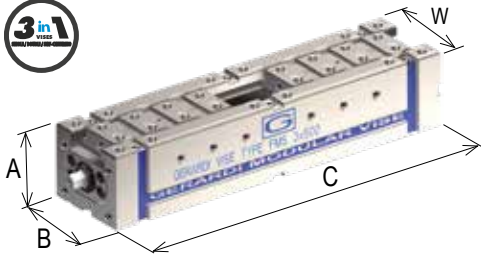

Tipo	Altezza base A	Larghezza base B	Lunghezza base C	Cod.	PREZZO LISTINO €	Cod.	PREZZO LISTINO €
2 (94mm) 25kN	90	95	400	5.85.52400	1.365	5.85.52400A	1.447
			500	5.85.52500	1.848	5.85.52500A	1.947
			600	5.85.52600	2.041	5.85.52600A	2.114
3 (124mm) 30kN	100	125	500	5.85.53500	1.773	5.85.53500A	1.864
			600	5.85.53600	2.452	5.85.53600A	2.559
4 (144mm) 30kN	120	145	600	5.85.54600	2.258	5.85.54600A	2.337

COMPONI LA TUA MORSA CON LE CENTINAIA DI GANASCE DISPONIBILI

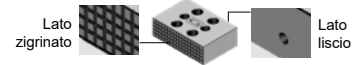

PER SERRAGGI DOPPI ED AUTOCENTRANTI

Art.860

Morsa doppia con ganasce zigrinate.

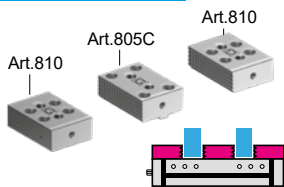

Tipo	Cod.	PREZZO LISTINO €	PREZZO OFFERTA €
2	5.86.02400	1.794	1.400
	5.86.02500	2.281	1.800
	5.86.02600	2.471	1.950
3	5.86.03500	2.264	1.800
	5.86.03600	2.941	2.300
4	5.86.04600	2.908	2.300

Art.863

Morsa doppia con ganasce a gradino

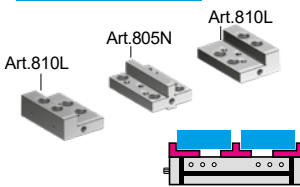

Tipo	Cod.	PREZZO LISTINO €	PREZZO OFFERTA €
2	5.86.32400	1.952	1.550
	5.86.32500	2.436	1.900
	5.86.32600	2.628	2.100
3	5.86.33500	2.420	1.900
	5.86.33600	3.098	2.450
4	5.86.34600	3.104	2.450

Art.865

Morsa doppia con ganasce a cambio rapido discendente (sistema a pettine)

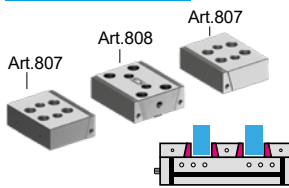

Tipo	Cod.	PREZZO LISTINO €	PREZZO OFFERTA €
2	5.86.52400	2.120	1.700
	5.86.52500	2.604	2.100
	5.86.52600	2.798	2.200
3	5.86.53500	2.735	2.200
	5.86.53600	3.418	2.700
4	5.86.54600	3.540	2.800

Art.866

Morsa doppia con ganasce oscillanti a gradino (3x5)

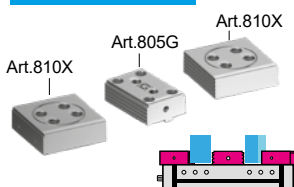

Tipo	Cod.	PREZZO LISTINO €	PREZZO OFFERTA €
2	5.86.02400	2.242	1.800
	5.86.02500	2.728	2.200
	5.86.02600	2.918	2.300
3	5.86.03500	2.761	2.200
	5.86.03600	3.439	2.700
4	5.86.04600	3.391	2.700

Art.867

Morsa doppia con ganasce oscillanti con inserti regolabili

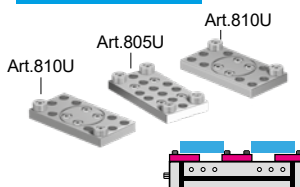

Tipo	Cod.	PREZZO LISTINO €	PREZZO OFFERTA €
2	5.86.72400	2.618	1.999
	5.86.72500	3.048	2.328
	5.86.72600	3.293	2.516
3	5.86.73500	3.171	2.423
	5.86.73600	3.850	2.941
4	5.86.74600	3.874	2.960

* SOLO AUTOCENTRANTI

* Per morsa SOLO autocentrante, distanziale Art.850T incluso nel prezzo

Art.855A

Corpo Base -
Solo Autocentrante

Art.810

2 Ganasce Zigrinate

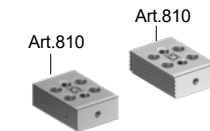
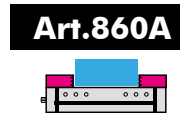

Tipo	* PREZZO LISTINO €
2	1.647
2	2.135
2	2.325
3	2.100
3	2.776
4	2.682

Art.855A

Corpo Base -
Solo Autocentrante

Art.810L

2 Ganasce a gradino

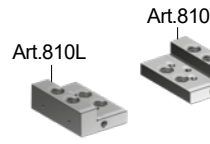
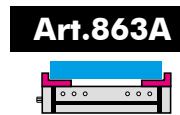

Tipo	* PREZZO LISTINO €
2	1.722
2	2.206
2	2.398
3	2.172
3	2.848
4	2.775

Art.855A

Corpo Base -
Solo Autocentrante

Art.807

2 Ganasce a cambio rapido discendente

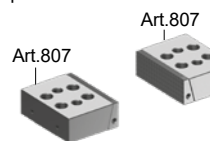
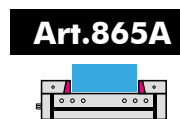

Tipo	* PREZZO LISTINO €
2	1.846
2	2.330
2	2.524
3	2.332
3	3.015
4	3.008

Art.855A

Corpo Base -
Solo Autocentrante

Art.814 (n°2)

Art.805V (n°2)

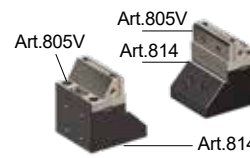
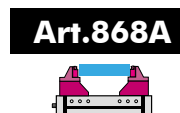

Tipo	* PREZZO LISTINO €
2	2.113
2	2.578
2	2.757
3	2.590
3	3.246
4	3.328

Art.855A

Corpo Base -
Solo Autocentrante

Art.810J

2 Ganasce prismatiche

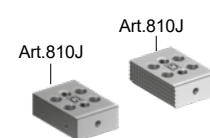
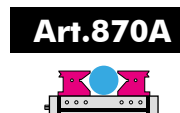

Tipo	* PREZZO LISTINO €
2	1.882
2	2.367
2	2.558
3	2.377
3	3.054
4	3.108

IDEALE PER CENTRI A 5 ASSI

Morse MULTIFLEX

Possano serrare fino a 19 particolari di dimensioni diverse - Ideali per centri verticali e ed orizzontali



Dot. standard: Chiave a "T", 2 tasselli di posizionamento e 4 arresti laterali. Ogni morsa è predisposta per il serraggio di 4 pezzi.

+ COMPRESO : 6 Staffe Art.298

(* Modelli predisposti per serrare 3 particolari)

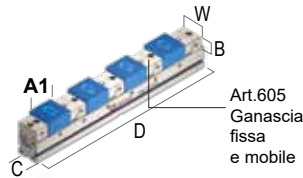

Art.605
Ganascia fissa
e mobile

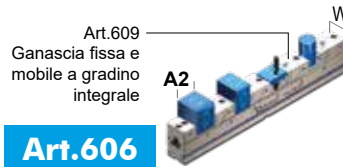

Art.609
Ganascia fissa e
mobile a gradino
integrale

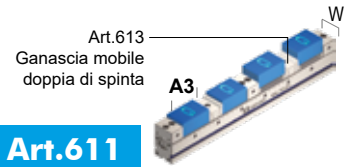

Art.613
Ganascia mobile
doppia di spinta

Art.600

Art.600W

Art.606

Art.611

Tipo	B	C ^{+0,002}	D	W	A1 mm	Cod.	PREZZO LISTINO €	PREZZO OFFERTA €	A2 mm	Cod.	PREZZO LISTINO €	PREZZO OFFERTA €	A3 mm	Cod.	PREZZO LISTINO €	PREZZO OFFERTA €
1 20kN	32/25	50	49	300	4x8	6.60.01300	1.204	749	* 3x19	6.60.61300	1.822	1.200	3x21	6.61.11300	1.822	1.200
				400	4x33	6.60.01400	1.308	849	4x23	6.60.61400	1.898	1.300	4x46	6.61.11400	1.898	1.300
				500	4x58	6.60.01500	1.425	949	4x48	6.60.61500	2.013	1.400	4x71	6.61.11500	2.013	1.400
				600	4x83	6.60.01600	1.553	1.049	4x73	6.60.61600	2.141	1.500	4x96	6.61.11600	2.130	1.500
				700	4x108	6.60.01700	1.736	1.149	4x97	6.60.61700	2.327	1.600	4x121	6.61.11700	2.327	1.600
2 30kN	40	75	74	400	4x12	6.60.02400	1.566	1.099	* 3x28	6.60.62400	2.266	1.550	4x34	6.61.12400	2.266	1.550
				500	4x37	6.60.02500	1.681	1.249	4x24	6.60.62500	2.386	1.650	4x59	6.61.12500	2.386	1.650
				600	4x62	6.60.02600	1.811	1.349	4x49	6.60.62600	2.517	1.750	4x84	6.61.12600	2.517	1.750
				700	4x87	6.60.02700	1.940	1.449	4x74	6.60.62700	2.647	1.850	4x109	6.61.12700	2.647	1.850
				800	4x112	6.60.02800	2.114	1.549	4x99	6.60.62800	2.832	1.950	4x134	6.61.12800	2.832	1.950
3 40kN	60	100	99	900	4x137	6.60.02900	2.302	1.749	4x124	6.60.62900	3.021	2.050	4x158,5	6.61.12900	3.021	2.050
				700	4x59	6.60.03700	2.244	1.649	4x44	6.60.63700	3.057	2.150	4x77	6.61.13700	3.057	2.150
				800	4x84	6.60.03800	2.428	1.749	4x69	6.60.63800	3.245	2.250	4x102	6.61.13800	3.245	2.250
				900	4x109	6.60.03900	2.619	1.949	4x94	6.60.63900	3.431	2.450	4x127	6.61.13900	3.431	2.450
				1000	4x134	6.60.03100	2.869	2.149	4x119	6.60.63100	3.682	2.650	4x152	6.61.13100	3.682	2.650

OFFERTA PIASTRE PARALLELE MAGNETICHE E RIPORTATE

Art.616

Coppia di piastre
parallele magnetiche
piane per Art.600



RISPARMI IL
20%

Solo se acquistate con la morsa



Art.610E

Piastra parallela
riportata per
Art.606

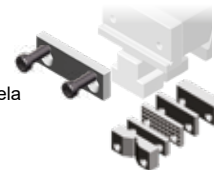

RISPARMI IL
20%

Solo se acquistate con la morsa

Morse MULTITASKING

Morse autocentranti o eccentriche - Ideali per centri di lavoro a 5 assi

Art.640

Possibile a richiesta
2 ganasce Art.645T
anziché Art.645E

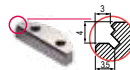

Dot. Standard : 1 arresto laterale, 1 chiave a pipa, 1 coppia di tasselli di orientamento Art.297, 1 perno di centraggio Art.640P

Tipo	1	2	3x166	3x266
Cod.	6.64.01000	6.64.02000	7.64.03166	7.64.03266
PREZZO LISTINO €	1.858	2.285	2.658	2.785
PREZZO OFFERTA €	1.049	1.249	2.039	2.124



Rialzo Semplice per morsa Art.640
MONTAGGIO INCLUSO

Art.641H

Compatibili

Tipo	1	2	3x166	3x266
Cod.	7.64.1H100AL /100	7.64.1H200AL /100	7.64.1H3166AL /100	7.64.1H3266AL /100
PREZZO LISTINO €	640	753	769	1.167
PREZZO OFFERTA €	400	450	600	900



Rialzo con zero point per morsa Art.640 per cambio rapido. Dot Standard : 1 tirante Art.10S / 11S 1 tappo teflon con O-ring Art.9 - 1 perno di centraggio Art.640P, -1 spina di orientamento Art.79

Art.63

Compatibili

Art.64

Tipo	1	2	2
Altezza H	100	125	163
Cod.	9.63.10000	9.63.20000	9.64.20000
PREZZO LISTINO €	1.222	2.066	3.448
PREZZO OFFERTA €	949	1.449	-

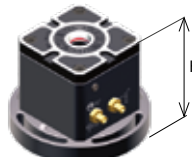

Art.645B

Ganascia
Dolce

Tipo	Cod.	PREZZO LISTINO €	PREZZO OFFERTA €
1	6.64.5B100	102	77
2	6.64.5B200	122	93
3	6.64.5B300	159	121

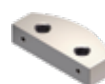

Art.645C

Ganascia
Liscia

Tipo	Cod.	PREZZO LISTINO €	PREZZO OFFERTA €
1	6.64.5C100	102	77
2	6.64.5C200	122	93
3	6.64.5C300	159	121

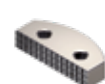

Art.645D

Ganascia
zigrinata

Tipo	Cod.	PREZZO LISTINO €	PREZZO OFFERTA €
1	6.64.5D100	102	77
2	6.64.5D200	122	93
3	6.64.5D300	159	121



Art.645E

Ganascia a
gradino

Tipo	Cod.	PREZZO LISTINO €	PREZZO OFFERTA €
1	6.64.5E100	115	87
2	6.64.5E200	134	102
3	6.64.5E300	171	130



Art.645F

Ganascia
prismatica

Tipo	Cod.	PREZZO LISTINO €	PREZZO OFFERTA €
1	6.64.5F100	129	98
2	6.64.5F200	146	111
3	6.64.5F300	185	141



Art.645T

Ganascia Grip
IN DOTAZIONE

Tipo	Cod.	PREZZO LISTINO €	PREZZO OFFERTA €
1	6.64.5T100	129	98
2	6.64.5T200	146	111
3	6.64.5T300	185	141

Cubi PORTAPEZZI

Fusioni in ghisa monoblocco con doppio trattamento di distensione - Per centri orizzontali

STANDARD GIAPPONESE

Art.53B

5th faccia lavorabile

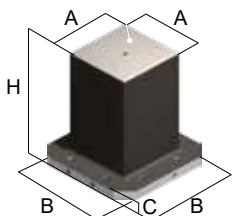

Cod.	A	B	C	D	H	Kg	PREZZO LISTINO €	PREZZO OFFERTA €
8.53.B00080	260	400	45	-	550	197	1.853	1.550
8.53.B00081	260	400	45	-	660	228	2.139	1.690
8.53.B00100	260	500	45	-	650	255	2.417	2.000
8.53.B00105	260	500	45	-	750	284	2.505	2.000
8.53.B00115	310	500	45	-	900	383	3.551	2.700
8.53.B00171	360	500	45	-	700	356	3.328	2.500
8.53.B00180	360	630	45	-	820	452	4.217	3.200
*8.53.B00211	510	630	45	-	860	61	5.858	3.850

* Solo per pallet a cave a "T"

Art.53B2 PLUS

Cod.	Kg	PREZZO LISTINO €	PREZZO OFFERTA €
8.53.B20080	182	2.361	1.950
8.53.B20081	204	2.680	2.050
8.53.B20100	238	3.027	2.400
8.53.B20105	254	3.138	2.500
8.53.B20115	354	4.311	3.300
8.53.B20171	326	4.041	3.050
8.53.B20180	427	5.277	4.200
8.53.B20211	593	7.113	4.350

Art.55B

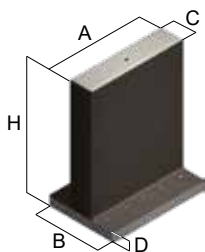

Cod.	A	B	C	D	H	Kg	PREZZO LISTINO €	PREZZO OFFERTA €
8.55.B00052	410	400	160	50	660	244	2.345	1.800
8.55.B00053	510	500	160	50	700	331	3.131	2.400
8.55.B00054	510	500	210	55	600	316	3.042	2.300
8.55.B00170	640	450	160	55	820	460	4.347	3.200
8.55.B00172	640	630	210	55	850	545	5.178	3.540
8.55.B00190	810	450	160	65	800	604	5.805	4.040

Art.55B2 PLUS

Cod.	Kg	PREZZO LISTINO €	PREZZO OFFERTA €
8.55.B20052	206	2.846	2.150
8.55.B20053	303	3.801	2.900
8.55.B20054	301	3.693	2.800
8.55.B20170	433	5.278	4.000
8.55.B20172	520	6.288	4.500
8.55.B20190	782	7.048	4.900

Art.57B

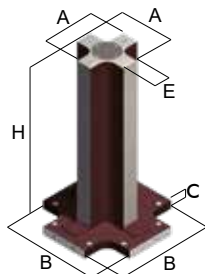

Cod.	A	B	C	D	H	Kg	PREZZO LISTINO €	PREZZO OFFERTA €
8.57.B00100	210	500	50	80	750	157	1.715	1.550
8.57.B00110	280	500	50	80	850	235	2.126	1.950
8.57.B00120	240	500	50	110	850	218	2.049	1.850
8.57.B00130	310	500	50	150	850	269	2.466	2.050
8.57.B00140	310	630	50	150	950	327	2.790	2.450

Art.57B2 PLUS

Cod.	Kg	PREZZO LISTINO €	PREZZO OFFERTA €
8.57.B20100	155	2.075	1.850
8.57.B20110	241	2.608	2.300
8.57.B20120	216	2.556	2.250
8.57.B20130	232	2.974	2.550
8.57.B20140	325	3.293	2.650

A Fusione in ghisa G30 monoblocco con doppio trattamento di distensione. Pareti spessore 43-45 mm. Tolleranza +12 / -5 mm

B Fusione con base lavorata e raschiata per pallet a norme Giapponesi. Predisposizione della base di appoggio di n.4 fori Ø 20F7 e filetto M16 con interessi precisi, pronte per l'utilizzo dei ns. Zero Point, oppure per l'interfacciamento con altri pallet o piastre. Pronto da installare ed azzerare con assi macchina. Tolleranza +12 / -5 mm

C Cubo completamente finito con pareti spessore 38-40 mm circa. Tolleranza ± 0,02 mm

B2 PLUS Sovrametallo 1mm su ogni faccia. Pronto da installare e da azzerare con assi macchina.

E Cubo a reticolo con fori calibrati e filetti integrali. Tolleranza ± 0,02 mm

F Cubo a reticolo con bussole temprate 100 Cr6 e filetti riportati in acciaio inox. Tolleranza ± 0,02 mm

CUBI E SPALLE VERSIONE LEGGERE

Art.53B1

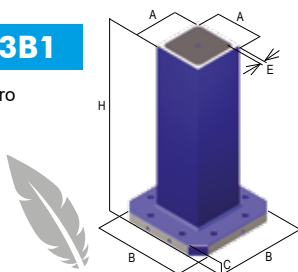
 Cubo Leggero
Base Finita

RISPARMI FINO AL 20%

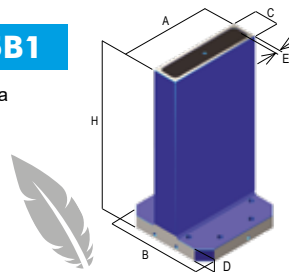
Art.55B1

 Spalla Leggera
Base Finita

RISPARMI FINO AL 20%

A	B	C	E	H	Kg	Cod.	PREZZO LISTINO €	PREZZO OFFERTA €
210	400	45	25	750	167	8.53.B10055	1.853	1.500
260	400	45	25	850	229	8.53.B10085	2.235	1.800
260	500	45	25	750	234	8.53.B10105	2.439	1.950
360	500	50	30	900	400	8.53.B10182	3.453	2.700
360	630	45	30	950	468	8.53.B10185	4.135	3.250
460	630	45	35	950	634	8.53.B10205	5.161	4.250

E = Spessore pareti - Wall tickness

A	B	C	D	E	H	Kg	Cod.	PREZZO LISTINO €	PREZZO OFFERTA €
410	400	110	55	25	750	193	8.55.B10045	2.111	1.700
410	400	160	55	25	850	239	8.55.B10050	2.343	1.900
510	500	160	55	25	750	277	8.55.B10053	2.757	2.200
510	500	210	55	30	900	402	8.55.B10085	3.531	2.800
640	630	210	55	30	950	553	8.55.B10172	4.753	3.700

E = Spessore pareti - Wall tickness

Unità e piastre ZERO POINT

Tempi di attrezzaggio ridotti del 90%, ripetibilità entro 0,005mm - Ideali per centri verticali, orizzontali e 5 assi

IL CLASSICO PNEUMATICO MULTIPLO

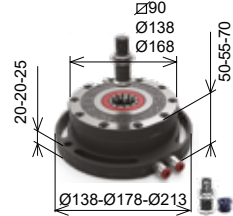

Art.664

CON FLANGIA

Tipo	Cod.	kN	Doppio Effetto kN	PREZZO LISTINO €	PREZZO OFFERTA €
1	9.66.41000	5,4	NON DISPONIBILE	632	499
2	9.66.42000	10	NON DISPONIBILE	951	599
3	9.66.43000	16	NON DISPONIBILE	1.194	999

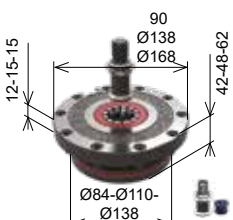

Art.665

INCASSATO

Tipo	Cod.	kN	Doppio Effetto kN	PREZZO LISTINO €	PREZZO OFFERTA €
1	9.66.51000	5,4	NON DISPONIBILE	509	399
2	9.66.52000	10	NON DISPONIBILE	826	499
3	9.66.53000	16	NON DISPONIBILE	1.075	899

L'ERMETICO PNEUMATICO SINGOLO

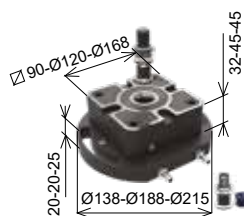

Art.664S

CON FLANGIA

DOPPIO EFFETTO ARIA+MOLLE

Tipo	Cod.	kN	Doppio Effetto kN	PREZZO LISTINO €	PREZZO OFFERTA €
1	9.66.4S100	5,4	12,7	732	599
2	9.66.4S200	10	27	1.037	699
3	9.66.4S300	16	40	1.194	999

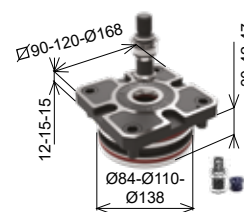

Art.665S

INCASSATO

DOPPIO EFFETTO ARIA+MOLLE

Tipo	Cod.	kN	Doppio Effetto kN	PREZZO LISTINO €	PREZZO OFFERTA €
1	9.66.5S100	5,4	12,7	610	499
2	9.66.5S200	10	27	914	599
3	9.66.5S300	16	40	1.075	899

Dot. Standard: 1 tirante Art.11A, 1 tappo teflon con O-Ring Art.9

Forza di serraggio 5 + 40 kN / Forza di arresto oltre a 60 kN / Sbloccaggio ad aria 6 + 10 bar / Compensazione assiale e radiale grazie alla pinza elastica integrale / Doppio centraggio per tirante per massima rigidità / Pulizia ad aria / Solo per ZERO POINT SINGOLI (versione S): 4 CHIAVETTE e FUNZIONE DOPPIOEFFETTO (Aria+molle)

KIT SOVRATAVOLE IN ACCIAIO INTERFACCIAE CON ZERO POINT PNEUMATICI

KIT #1 E #2 POSIZIONAMENTO & FISSAGGIO INCLUSI

KIT #3 e #4 POSIZIONAMENTO E FISSAGGIO STANDARD INCLUSO E FISSAGGIO SPECIFICO EXTRA*

KIT #1 PER CENTRI VERTICALI

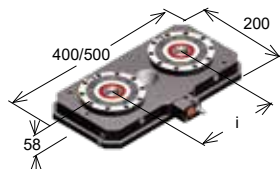

Art.81P PIASTRA BASE	PREZZO LISTINO €	PREZZO OFFERTA €
200x400 (i=200)	2.724	1.749
200x500 (i=250)	2.793	1.849

KIT #2 PER CENTRI ORIZZONTALI

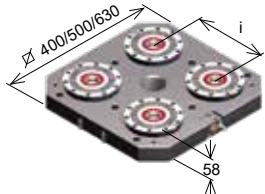

Art.80P PIASTRA BASE	PREZZO LISTINO €	PREZZO OFFERTA €
400x400 (i=200)	4.880	3.299
500x500 (i=250)	5.107	3.499
630x630 (i=300)	5.595	3.999

KIT #3 PER CENTRI VERTICALI

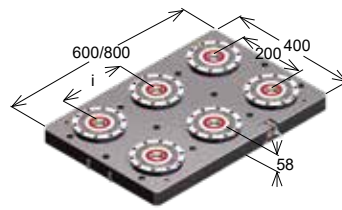

Art.81P PIASTRA BASE	PREZZO LISTINO €	PREZZO OFFERTA €
400x600 (i=200)	7.035	4.699
400x800 (i=300)	7.332	4.899

KIT #4 PER CENTRI A 5 ASSI

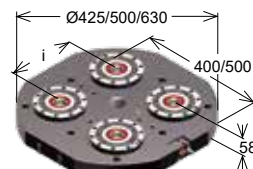

Art.82P PIASTRA BASE TONDA	PREZZO LISTINO €	PREZZO OFFERTA €
Ø425 (i=200)	5.107	3.399
Ø500 (i=250)	5.085	3.499
Ø630 (i=300)	5.674	3.999

PIASTRE D'INTERFACCIA PER PIASTRE ZERO POINT

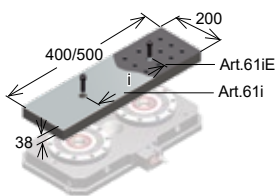

Art.61iC LISCE	PREZZO LISTINO €	PREZZO OFFERTA €
200x400 (i=200)	936	599
200x500 (i=250)	1.006	649

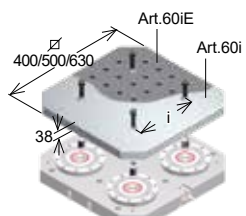

Art.60iC LISCE	PREZZO LISTINO €	PREZZO OFFERTA €
400x400 (i=200)	1.146	863
500x500 (i=250)	1.380	1.039
630x630 (i=300)	1.730	1.303

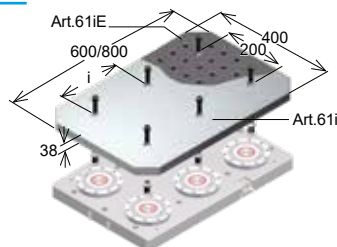

Art.61iC LISCE	PREZZO LISTINO €	PREZZO OFFERTA €
400x600 (i=200)	1.753	1.320
400x800 (i=300)	2.337	1.760

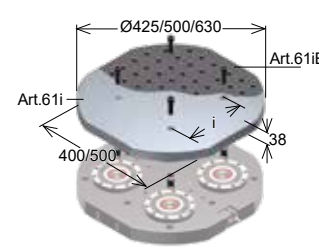

Art.62iC LISCE	PREZZO LISTINO €	PREZZO OFFERTA €
Ø425 (i=200)	1.228	924
Ø500 (i=250)	1.402	1.056
Ø630 (i=300)	1.636	1.232

Art.61iE A RETICOLO INTEGRALE	PREZZO LISTINO €	PREZZO OFFERTA €
200x400 (i=200)	1.135	649
200x500 (i=250)	1.250	749

Art.60iE A RETICOLO INTEGRALE	PREZZO LISTINO €	PREZZO OFFERTA €
400x400 (i=200)	1.505	1.040
500x500 (i=250)	1.968	1.360
630x630 (i=300)	3.090	2.136

Art.61iE A RETICOLO INTEGRALE	PREZZO LISTINO €	PREZZO OFFERTA €
400x600 (i=200)	2.083	1.440
400x800 (i=300)	2.962	2.048

Art.62iE A RETICOLO INTEGRALE	PREZZO LISTINO €	PREZZO OFFERTA €
Ø425 (i=200)	1.505	1.040
Ø500 (i=250)	1.921	1.328
Ø630 (i=300)	2.569	1.776

Morse GRIP MATIC

Morsa automatica pneumatica o idraulica a doppio effetto - Ideale per centri a 5 assi

Art.670

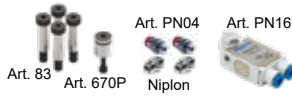

Dot. Standard: - 4x Viti calibrate (Art.83) - Perno di centraggio (Art.670P)
- 2 Niplon o 2 raccordi Art.PN04 - Valvola di non ritorno (Art.PN16)



Modulo base morsa autocentrante idraulica o pneumatica

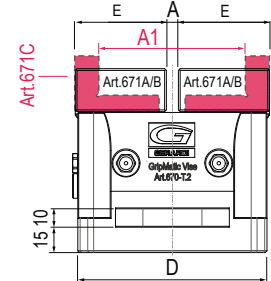
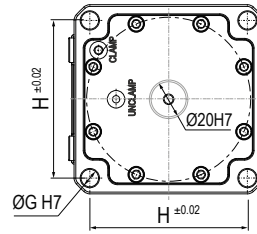
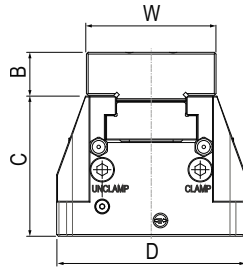

Tipo	Larghezza ganascia W	Apertura minima A	Apertura massima A1	Altezza morsa C+B	Altezza base C	Larghezza morsa D	Lunghezza ganascie E	Interasse fori di centraggio e fissaggio H	PNEUMATICO ART.670 Cod.		IDRAULICO ART.670 Cod.		PREZZO LISTINO €	PREZZO OFFERTA €	
									Pressione di esercizio	Forza	Pressione di esercizio	Forza			
2	74	6,4	88,9	105	80	106	52	90	7 kN	7.67.0PN20	30BAR	19 kN	7.67.0ID20	1.790	1.400
3	99	8,5	130,2	135	105	166	78	140	14,4 kN	7.67.0PN30	30BAR	37,5 kN	7.67.0ID30	2.387	1.850
4	124	12	162	165	130	206	96	170	16,9 kN	7.67.0PN40	25 BAR	47 kN	7.67.0ID40	3.162	2.400



Art.671A
Ganascia lavorabile



Art.671B
Ganascia lavorabile ridotta

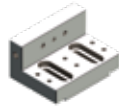

Art.671C
Ganascia lavorabile ridotta



Art.243
Piastra ganascia piana rigata temprata



Art.245
Piastra ganascia piana liscia temprata



Art.247G
Piastra piana con inserti GRIP

PIASTRE D'INTERFACCIA PER MORSE GRIPMATIC - IDEALI PER CENTRI A 5 ASSI

Art.670CP

SEMI-AUTOMATICA

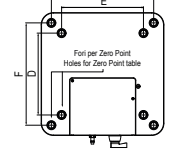
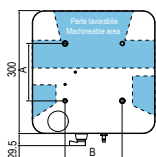
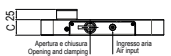
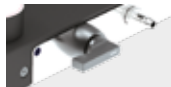

Piastra di interfaccia per morsa Grip Matic Art.670 PN semiautomatica con innesto aria tramite attacco rapido e apertura e chiusura gestiti manualmente tramite selettore

Tipo	Interasse fori A	Interasse fori B	Altezza piastra C	Interasse fori (Zero Point) D	Interasse fori (Zero Point) E	Interasse fori (Zero Point) F	Interasse fori (Zero Point) G	Pressione di esercizio	Forza	Cod.	PREZZO LISTINO €
2	90	90	38	200	200	250	250	Max 10BAR	7 kN	7.67.0CP20	2.271
3	140	140	38	200	200	250	250		14,4 kN	7.67.0CP30	2.271
4	170	170	38	200	200	250	250		16,9 kN	7.67.0CP40	2.271

Art.670AP

AUTOMATICA



Piastra di interfaccia per morsa Grip Matic Art.670PN automatica con innesto aria tramite la tavola della macchina e gestibile direttamente dal CNC. Piastra completamente personalizzabile in base alle funzionalità della macchina utensile (comando di presenza pezzo e pulizia)

* Prezzo base minimo, PERSONALIZZAZIONE INCLUSA

PIASTRA PERSONALIZZABILE AL 100%

Tipo	Pressione di esercizio	Forza	Cod.	PREZZO LISTINO €*
2	Max 10BAR	7 kN	7.67.0AP20	2.497
3		14,4 kN	7.67.0AP30	2.497
4		16,9 kN	7.67.0AP40	2.497

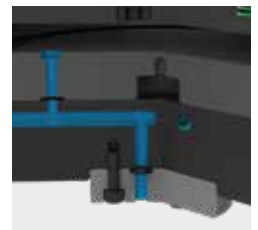

DUODUX

L'autocentrante doppia guida italiano

DIN
6350

Dot. standard: 1 set da 3 griffe con presa interna, 1 set da 3 griffe con presa esterna, 1 chiave mandrino per apertura griffe

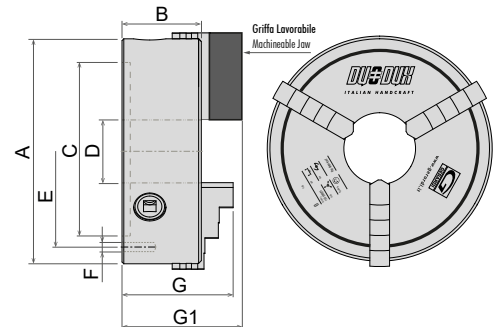
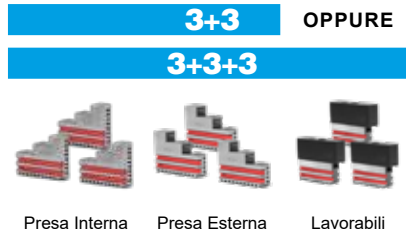

	A	B	C h6	D	E	F	G	G1	daN	Rpm
GUIDA SINGOLA	Ø160	70,5	130	42	144,5	N°3 M8	89,5	106	3.100	Max 3.600
DOPPIA GUIDA	Ø200	81	160	53	176	N°3 M10	113	132,5	3.700	Max 3.000
DOPPIA GUIDA	Ø250	88,5	200	80	224	N°6 M12	124	149,5	4.600	Max 2.500
DOPPIA GUIDA	Ø310	100,5	260	108	286	N°3 M12	143,5	162,5	5.500	Max 2.000
DOPPIA GUIDA	Ø365	105,5	310	126,5	336,5	N°6 M14	155	168	5.900	Max 1.800
DOPPIA GUIDA	Ø430	114	382	170	405	N°6 M14	170	176,5	6.900	Max 1.400



3+3					3+3+3				
A	Kg	Cod.	PREZZO LISTINO €	PREZZO OFFERTA €	Kg	Cod.	PREZZO LISTINO €	PREZZO OFFERTA €	
GUIDA SINGOLA Ø160	8	GMD-160-3G20	1.067	854	10	GMD-160-3G30	1.333	1.067	
DOPPIA GUIDA Ø200	15	GDD-200-3G20	1.156	925	18	GDD-200-3G30	1.444	1.156	
DOPPIA GUIDA Ø250	23	GDD-250-3G20	1.358	1.086	27	GDD-250-3G30	1.650	1.320	
DOPPIA GUIDA Ø310	38	GDD-310-3G20	1.984	1.588	44	GDD-310-3G30	2.319	1.855	
DOPPIA GUIDA Ø365	61	GDD-365-3G20	3.092	2.474	71	GDD-365-3G30	3.760	3.008	
DOPPIA GUIDA Ø430	92	GDD-430-3G20	4.345	3.476	103	GDD-430-3G30	5.180	4.144	



PRECISIONE, RIGIDITÀ & STABILITÀ ANCHE IN LAVORAZIONI GRAVOSE

DUO-DUX, il mandrino autocentrante manuale a doppia guida 100% Made in Italy. Composto da griffe integrali a guida doppia in grado di supportare maggiori carichi di lavoro e garantire una maggior stabilità. La corona è rettificata con uno speciale metodo da noi sviluppato atto a garantire elevata precisione e ripetibilità. Ogni autocentrante DUO-DUX viene equilibrato secondo la norma ISO3089/74, testato singolarmente e fornito di apposito certificato di collaudo e garanzia. Gli autocentranti di diametro 365 e 430mm, indicati per lavorazioni pesanti, conservano al contempo le stesse doti tecniche di precisione dei mandrini di minor diametro.

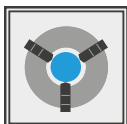
PIÙ ALTA RIGIDITÀ

GARANTITO 5 ANNI

CORPO IN GHISA

Versione speciale Ø270-105

Oltre ai diametri della gamma standard è disponibile una versione speciale con Ø270 e passaggio barra maggiorato Ø105.

Cod. GDD-270-3G20-105

Griffe Integrali

Le griffe integrali per il serraggio sono realizzate in acciaio al nichel-cromo cementato, temprato e rettificato a garantire elevata precisione e ripetibilità.

Doppia guida

Il sistema a doppia guida degli autocentranti DuoDux è in grado di supportare maggiori carichi di lavoro e garantire maggior stabilità.

5 Anni di Garanzia

Sicuri dell'affidabilità e dell'elevata qualità dei componenti impiegati per la realizzazione degli autocentranti DuoDux riconosciamo 5 anni di garanzia sull'intera gamma.

Portautensili STATICI

Risparmia con i kit di statici e bussole di riduzioni - A scelta tra la gamma a catalogo



SCANSIONA IL QR CODE E SCEGLI TRA L'INTERA GAMMA DI COSTRUTTORI DI STATICI PRESENTI A CATALOGO

DIN 69880

DMG MORI

Mazak

LOKUMA

BMT

Bolt Mounted Turret



Nakamura-Tome



TSUGAMI CORPORATION

Richiedi la password al tuo agente di zona

ESEMPIO KIT 1

3 PCS

RISPARMI IL
10%

ACQUISTANDO 3 PORTAUTENSILI STATICI

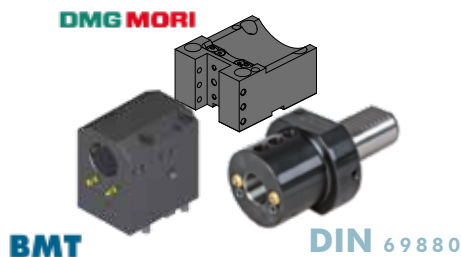

ESEMPIO KIT 2

4 PCS

RISPARMI IL
15%

ACQUISTANDO 4 PORTAUTENSILI STATICI

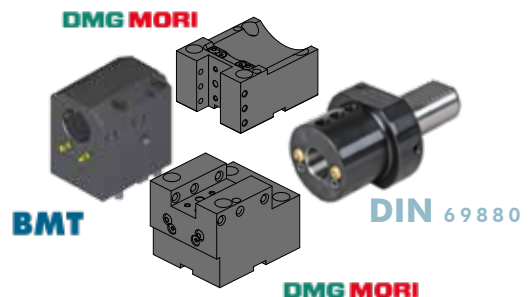

Cambi rapidi MODULARI

Nuovi cambi rapidi universali 2.0 - Compatibili con tutte le uscite ER

RISPARMI FINO AL
50%

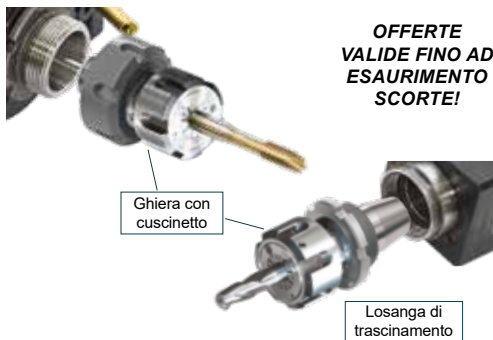

BREVETTO DEPOSITATO
LOSANGA DI TRASCINAMENTO



PREZZO DI LISTINO 425€ CAD.

- Tempi di installazione ridotti e possibilità di presetting a bordo macchina
- Nuovi cambi rapidi modulari 2.0 a FORTE SER-RAGGIO
- Portautensili modulari compatibili con tutte le uscite ER
- Prestazioni garantite e maggior rigidità sui motorizzati Gerardi grazie alla losanga di trascinamento (rimovibile) e alla ghiera con cuscinetto a sfera
- Adattabili a motorizzati con uscita refrigerante sia interna che esterna
- Si consiglia di non superare i 10.000Rpm utilizzando i cambi rapidi

3 PCS

ACQUISTANDO UN
3 CAMBI RAPIDI
(GHIERA INTERNA O ESTERNA)



RISPARMI IL
20%

4 PCS

ACQUISTANDO UN
4 CAMBI RAPIDI
(GHIERA INTERNA O ESTERNA)



RISPARMI IL
25%

WOOW

ACQUISTA UN MOTORIZZATO CON USCITA
ER25, ER32 o ER40
1 CAMBIO RAPIDO A SCELTA
(GHIERA INTERNA O ESTERNA)



RISPARMI IL
50%

Sul Cambio Rapido

Portautensili MOTORIZZATI

Motorizzati per torni cnc - L'eccellenza tecnologica

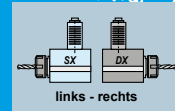

BMT

Bolt Mounted Turret

COMPATIBILI CON TORNI

DOOSAN / HARDINGE / SAMSUNG / HWACHEON / HYUNDAI WIA / VICTOR / HAAS

BMT 65 COMPATIBILI ANCHE CON TORNI HAAS!

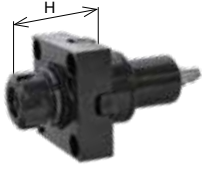

80 BAR

Assiali

BMT	Cod.	ER	H Max	Nm Rpm	PREZZO LISTINO €	PREZZO OFFERTA €
45	99.DS.A03	25	57,2	35 8000	1.033	839
	99.DS.A04	25	57,2	35 8000	1.179	929
55	99.DS.A01	25	57,2	40 8000	1.363	899
	99.DS.A02	25	57,2	40 8000	1.243	979
65 HAAS READY!	99.DS.A41	32	72,5	70 6000	1.274	1.049
	99.DS.A42	32	72,5	70 6000	1.465	1.179
75	99.DS.A34	40	90,2	100 6000	1.497	1.249
	99.DS.A35	40	90,2	100 6000	1.720	1.399



80 BAR

Radiali

BMT	Cod.	ER	H	Nm Rpm	PREZZO LISTINO €	PREZZO OFFERTA €
45	99.DS.A07C	25	65	35 8000	1.822	1.499
	99.DS.A08C	25	65	35 8000	2.190	1.799
55	99.DS.A11C	25	70	40 8000	2.038	1.599
	99.DS.A12C	25	70	40 8000	2.408	1.899
65 HAAS READY!	99.DS.A51C	32	72	70 6000	2.140	1.699
	99.DS.A52C	32	72	70 6000	2.534	1.999
75	99.DS.A38C	40	60	100 6000	3.311	2.649
	99.DS.A39C	40	60	100 6000	3.973	3.099



80 BAR

Orientabili

BMT	Cod.	ER	H	Nm Rpm	PREZZO LISTINO €	PREZZO OFFERTA €
45	99.DS.A16	20	65	15 8000	4.698	3.899
	99.DS.A17	20	65	15 8000	6.111	4.699
55	99.DS.A23	20	65	15 8000	4.698	3.899
	99.DS.A66	20	65	15 8000	6.111	4.699
65 HAAS READY!	99.DS.A64	25	75	25 6000	5.221	4.299
	99.DS.A65	25	75	25 6000	6.748	5.199
75	99.DS.A47	25	75	25 6000	5.221	4.299
	99.DS.A48	25	75	25 6000	6.748	5.199

Entrambe direzioni di rotazione disponibili

Tenone Maggiorato a Richiesta

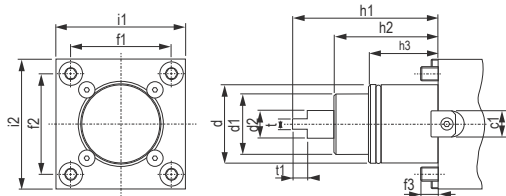

BMT	c1	d	d1	d2	f1	f2	f3	h1	h2	h3	i1	i2	t	t2	h4	N	ØM
45	15	Ø45	35	14	58	58	10	84	60	40	75	75	6	8,5	-	-	-
55	15	Ø55	40	16	64	64	14	104	75	30	85	85	8	8,5	9,5	8	29
65	18	Ø65	45	18	70	73	15	112	83	32	94	94	10	14	15	10	29
75	25	Ø75	55	23	90	90	15	110	80	43	112	112	14	15	-	-	-
85	25	Ø85	65	33,5	100	100	18	140	100	43	125	125	16	20	-	-	-

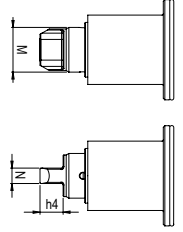

IN OFFERTA LE NUOVE GAMME DI MOTORIZZATI

Mazak QTN3

QUICK TURN NEXUS QTN
300 / 350 / 400 / 450 -
SQT 28 / 30 - 300

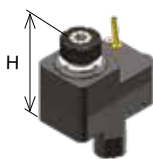

80 BAR

Disassati

Cod.	ER	H	Nm Rpm	PREZZO LISTINO €	PREZZO OFFERTA €
99.MZ.A71	40	145	100 4000	3.320	3.100
99.MZ.A72	40	145	100 4000	3.631	3.300

Mazak QTN2

12 Posizioni

QUICK TURN NEXUS
QTN 200 / 250
SUPER QUADREX TURN
SQT 15/18 - 200 / 250

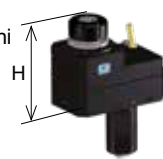

80 BAR

Cod.	ER	H	Nm Rpm	PREZZO LISTINO €	PREZZO OFFERTA €
99.MZ.A58	32	120	80 6000	2.491	1.549
99.MZ.A59	32	120	80 6000	3.010	2.100

Mazak SMART QTS1

- BMT68

QUICK TURN SMART
QTS 100M / 200M
QT COMPACT 100M -
200M - 300M



80 BAR

Cod.	ER	H Max	Nm Rpm	PREZZO LISTINO €	PREZZO OFFERTA €
99.MZ.A03	32	70	60 6000	1.972	1.749
99.MZ.A06	32	70	60 6000	2.387	2.149



80 BAR

Radiali

Cod.	ER	H	Nm Rpm	PREZZO LISTINO €	PREZZO OFFERTA €
99.MZ.A75	40	160	100 4000	3.424	3.200
99.MZ.A81	40	160	100 4000	3.943	3.600



80 BAR

Cod.	ER	H	Nm Rpm	PREZZO LISTINO €	PREZZO OFFERTA €
99.MZ.A58	32	120	80 6000	2.491	1.549
99.MZ.A59	32	120	80 6000	3.010	2.100

Senso di rotazione contrario al mandrino



80 BAR

Cod.	ER	H	Nm Rpm	PREZZO LISTINO €	PREZZO OFFERTA €
99.MZ.A09	32	80	60 6000	2.698	2.299
99.MZ.A10	32	80	60 6000	2.906	2.599

Senso di rotazione contrario al mandrino

Portautensili **MOTORIZZATI**

Motorizzati per torni cnc - L'eccellenza tecnologica

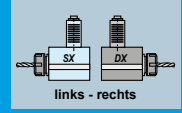

DIN 5480

VDI - DIN69880

* In caso di ordine specificare sempre se sinistro o destro

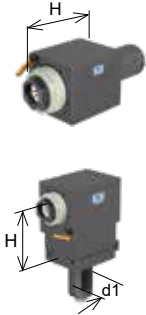

d1	Cod.	ER	H	Nm	Rpm	PREZZO LISTINO €	PREZZO OFFERTA €
30	99.ST.8003	25	66	32	6000	917	779
	99.ST.8011	25	66	32	6000	1.185	979
40	99.ST.8005	32	95	63	6000	1.147	999
	99.ST.8013	32	95	63	6000	1.499	1.229
Senso di rotazione uguale al mandrino							
30	99.ST.8030	25	55	32	6000	1.926	1.599
	99.ST.8038	25	55	32	6000	2.216	1.829
40	99.ST.8033	32	100	63	6000	2.436	1.999
	99.ST.8041	32	100	63	6000	2.798	2.299
Senso di rotazione contrario al mandrino							

DIN 5482

VDI - DIN69880

* In caso di ordine specificare sempre se sinistro o destro

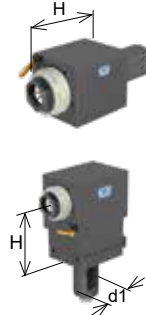

d1	Cod.	ER	H	Nm	Rpm	PREZZO LISTINO €	PREZZO OFFERTA €
30	99.ST.8201	25	94	32	6000	865	779
	99.ST.8207	25	94	32	6000	1.161	979
40	99.ST.8203	32	115	63	5000	1.041	899
	99.ST.8208	32	115	63	5000	1.347	1.129
Senso di rotazione uguale al mandrino							
30	99.ST.8217	25	55	32	6000	1.735	1.449
	99.ST.8223	25	55	32	6000	2.025	1.699
40	99.ST.8220	32	100	63	5000	2.078	1.699
	99.ST.8226	32	100	63	5000	2.430	1.999
Senso di rotazione contrario al mandrino							



VDI - DIN69880

* In caso di ordine specificare sempre se sinistro o destro

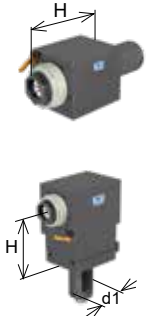

d1	Cod.	ER	H	Nm	Rpm	PREZZO LISTINO €	PREZZO OFFERTA €
30	99.BF.0003	25	94	32	6000	895	779
	99.BF.0010	25	94	32	6000	1.193	979
40	99.BF.0005	32	117	63	5000	1.079	929
	99.BF.0011	32	115	63	5000	1.391	1.179
Senso di rotazione uguale al mandrino							
30	99.BF.0021	25	55	32	6000	1.781	1.499
	99.BF.0027	25	55	32	6000	2.086	1.749
40	99.BF.0024	32	100	63	5000	2.140	1.749
	99.BF.0030	32	100	63	5000	2.506	2.049
Senso di rotazione contrario al mandrino							

DIN 1809

VDI - DIN69880

* In caso di ordine specificare sempre se sinistro o destro

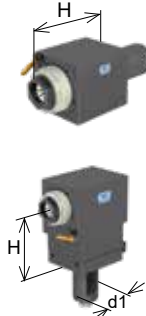

d1	Cod.	ER	H	Nm	Rpm	PREZZO LISTINO €	PREZZO OFFERTA €
30	99.DP.0903	25	94	32	6000	865	779
	99.DP.0910	25	94	32	6000	1.161	979
40	99.DP.0905	32	115	63	5000	1.041	879
	99.DP.0911	32	115	63	5000	1.347	1.129
Senso di rotazione uguale al mandrino							
30	99.DP.0919	25	55	32	6000	1.735	1.449
	99.DP.0925	25	55	32	6000	2.025	1.699
40	99.DP.0922	32	100	63	5000	2.078	1.699
	99.DP.0928	32	100	63	5000	2.430	1.999
Senso di rotazione contrario al mandrino							



NUOVA GAMMA BMT 55

CORPO MONOBLOCCO NICHELATO



d1	Cod.	Biglia Code	ER	H	Nm	Rpm	PREZZO LISTINO €	PREZZO OFFERTA €
55	99.BG.A01	10.57.88.00	25	70	47	6000	887	699
	99.BG.A02	T.134-00061	32	70	47	6000	887	699
Senso di rotazione uguale al mandrino								
55	99.BG.A03	T.134-00071	32	70	47	6000	1.227	949



d1	Cod.	Biglia Code	ER	H	Nm	Rpm	PREZZO LISTINO €	PREZZO OFFERTA €
55	99.BG.A05	10.57.87.00	25	70	47	6000	1.661	1.249
	99.BG.A06	T.134-00062	32	70	47	6000	1.661	1.249
	99.BG.A07	T.134-00072	32	70	47	6000	2.179	1.649
	99.BG.A08	T.134-00076	25	100	47	6000	1.868	1.399
	99.BG.A09	T.134-00077	32	100	47	6000	1.868	1.399
	99.BG.A10	T.134-00088	32	100	47	6000	2.179	1.649
Senso di rotazione uguale al mandrino								

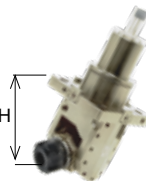

d1	Cod.	Biglia Code	ER	H	Nm	Rpm	PREZZO LISTINO €	PREZZO OFFERTA €
55	99.BG.A15	T.134-00025	16	60	16	6000	3.830	2.849
	99.BG.A16	T.134-00057	20	60	16	6000	3.830	2.849
Senso di rotazione uguale al mandrino								



NLX 1500 - 2000 - 2500 - 3000

12 Posizioni

NZX 12 Posizioni



Cod.	ER	H Max	Nm	Rpm	PREZZO LISTINO €	PREZZO OFFERTA €
99.MS.A59	32	89,9	60	10.000	1.249	999
99.MS.A60	32	89,9	60	10.000	1.847	1.429
99.MS.A62	40	92	60	10.000	1.249	999
99.MS.A63	40	92	60	10.000	1.847	1.429
99.MS.A72	32	90	60	10.000	2.674	2.099
99.MS.A73	32	90	60	10.000	2.993	2.349
99.MS.A76	40	90	60	10.000	2.674	2.099
99.MS.A77	40	90	60	10.000	2.993	2.349

Entrambe direzioni di rotazione disponibili*

NZ 1500 - 2000 - 3100 - 3150 - 3200

16 Posizioni



Cod.	ER	H Max	Nm	Rpm	PREZZO LISTINO €	PREZZO OFFERTA €
99.MS.A101	25	84,3	50	12.000	1.249	1.049
99.MS.A102	25	84,3	50	12.000	1.847	1.479
99.MS.A103	32	89,2	50	12.000	1.249	1.049
99.MS.A104	32	89,2	50	12.000	1.847	1.479
Senso di rotazione uguale al mandrino						
99.MS.A106	25	85	50	12.000	2.674	2.099
99.MS.A107	25	85	50	12.000	2.993	2.349
99.MS.A108	32	85	50	12.000	2.674	2.099
99.MS.A109	32	85	50	12.000	2.993	2.349
Senso di rotazione contrario al mandrino						

Portautensili **MOTORIZZATI**

Motorizzati per torni cnc - L'eccellenza tecnologica

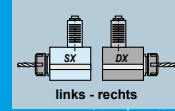

VDI 40

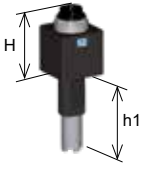

Cod.	ER	H	h1	Nm	Rpm	PREZZO LISTINO €	PREZZO OFFERTA €
99.HA.590082	32	75	117,5	63	6000	945	749
99.HA.590082B	32	75	117,5	63	6000	1.179	899
99.HA.590083	32	75	104,8	63	6000	945	749
99.HA.590083B	32	75	104,8	63	6000	1.179	899
99.HA.596352	32	75	130,25	63	6000	945	749
99.HA.596352B	32	75	130,25	63	6000	1.179	899

Senso di rotazione uguale al mandrino



* Presa di moto intercambiabile per le varie tipologie di torrette Haas

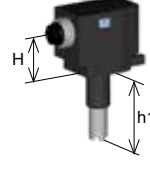

Cod.	ER	H	h1	Nm	Rpm	PREZZO LISTINO €	PREZZO OFFERTA €
99.HA.590084	32	75	117,5	63	6000	1.773	1.349
99.HA.590084B	32	75	117,5	63	6000	2.240	1.699
99.HA.590085	32	75	104,8	63	6000	1.773	1.349
99.HA.590085B	32	75	104,8	63	6000	2.240	1.699
99.HA.596353	32	75	130,25	63	6000	1.773	1.349
99.HA.596353B	32	75	130,25	63	6000	2.240	1.699

Senso di rotazione uguale al mandrino



Ø45: WT100 -TW1
Ø54: WT100 -TW1



d1	Cod.	ER	H Max	Nm	Rpm	PREZZO LISTINO €	PREZZO OFFERTA €
45	99.MY.A02	25	57,6	35	6000	853	749
	99.MY.A03	25	57,6	35	6000	1.022	899
54	99.MY.A09	32	79,4	60	6000	993	849
	99.MY.A10	32	79,4	60	6000	1.140	949
45	99.MY.A05	25	65	35	6000	1.506	1.249
	99.MY.A06	25	65	35	6000	2.456	1.649
54	99.MY.A11	32	75	60	6000	1.868	1.549
	99.MY.A12	32	75	60	6000	2.207	1.849

Senso di rotazione contrario al mandrino



BMT44 WT100 -TW1
BMT55 SUPER NTJ-NTJX/NTM 3/TMC 18/
TW10/SC150-250/WT150-250/WTW 150/WTS 150/WT100



d1	Cod.	ER	H Max	Nm	Rpm	PREZZO LISTINO €	PREZZO OFFERTA €
45	99.NK.A40	25	57,2	40	6000	946	799
	99.NK.A43	25	57,2	40	6000	1.081	899
55	99.NK.A03	32	72,2	63	6000	993	849
	99.NK.A04	32	72,2	63	6000	1.530	1.299
45	99.NK.A50	25	60	40	6000	1.676	1.399
	99.NK.A53	25	60	40	6000	2.008	1.699
55	99.NK.A13	32	55	63	6000	1.868	1.549
	99.NK.A14	32	55	63	6000	2.519	2.099

Senso di rotazione uguale al mandrino



BMT60: SPACE TURN LB 200EX/LB 2500EX/LB3000EX/GENOS SERIES L300-MW/
MULTUS U3000/U40007/LU3000EX M/MY



d1	Cod.	ER	H Max	Nm	Rpm	PREZZO LISTINO €	PREZZO OFFERTA €
60	99.OK.A80	32	79	60	6000	1.687	1.299
	99.OK.A81	32	79	60	6000	2.141	1.599

Senso di rotazione uguale al mandrino



60	99.OK.A82	32	70	60	6000	3.048	2.299
	99.OK.A83	32	70	60	6000	3.631	2.749

Senso di rotazione contrario al mandrino



VDI40 OKUMA CAPTAIN L370 M - ES L10 M - GENOS L300, L3000-E M/MY (VDI40)
LB 300 MW - LB/LU 300 MY - LB/LU 300, 3000 M (VDI40)



Assiali

Cod.	ER	H	Nm	Rpm	PREZZO LISTINO €	PREZZO OFFERTA €
99.OK.A18	32	98,6	70	6000	1.947	1.499
99.OK.A23	32	98,6	70	6000	2.465	1.899

Radiali

99.OK.A19	32	70	60	6000	3.373	2.549
99.OK.A25	32	70	60	6000	4.151	3.149



BMT60 EX 380 / 310 / 508 / 510 / 708 / 710 / 910 - EX 2000 M/Y - TC 350 MC - TT 350 MC - NEX 108/110/908/910 - LA 200/250 M/Y - LA 250 YS (15 stations) - FX 800 - MX 800 - VTL 450 M - LX 2500 M/Y



Assiali

Cod.	ER	H	Nm	Rpm	PREZZO LISTINO €	PREZZO OFFERTA €
99.TK.A12	32	93	50	6000	1.499	1.149
99.TK.A13	32	93	50	6000	2.213	1.699

Radiali

99.TK.A02	32	90	50	6000	3.139	2.399
99.TK.A05	32	90	50	6000	3.333	2.549



BMT65: M06D/M06SD/M06SY/M08SD/M08SY



Cod.	ER	H Max	Nm	Rpm	PREZZO LISTINO €	PREZZO OFFERTA €
99.TS.A01	25	60	40	8000	1.558	1.199
99.TS.A02	25	60	40	8000	2.141	1.649



99.TS.A08	25	65	40	8000	2.529	1.949
99.TS.A09	25	65	40	8000	3.112	2.449



TESTE ANGOLARI e MOLTIPLICATORI di Giri

Novità!! Da oggi anche le teste angolari classic line a prezzo speciale



DOTAZIONE STANDARD

Valigetta / Stop block / Ghiera ER /
Chiavi di servizio /
Tubetto di grasso / Libro istruzioni

Vai alla pagina
di catalogo per
approfondire



ISO
CAT /
BT /**40**

**STOP BLOCK
INCLUSO**

STD 90°
SERIES



Ratio
1:1



Rpm
8.000



Kg 5.4



ER25
Ø1/16

CLASSIC LINE ATC

G90-16

Prezzo Listino ~~€ 3.598~~
Prezzo Speciale: **€ 3.000**

DOTAZIONE STANDARD

Valigetta / Stop block / Ghiera ER /
Chiavi di servizio /
Tubetto di grasso / Libro istruzioni

Vai alla pagina
di catalogo per
approfondire



ISO
CAT /
BT /**50**

**STOP BLOCK
INCLUSO**

STD 90°
SERIES



Ratio
1:1



Rpm
4.000



Kg 11



ER32
Ø2/20

CLASSIC LINE ATC

G90-20

Prezzo Listino ~~€ 3.804~~
Prezzo Speciale: **€ 3.200**

AMPIA GAMMA DI MODELLI
quasi 200 modelli di teste
classic line disponibili

MASSIMA RIGIDITÀ
grazie ad albero e cono
integrali realizzati in un pezzo
unico

CORPO ORIENTABILE A 360°
in acciaio temprato, massima
rigidità e resistenza alla
corrosione

CUSCINETTI ABEC 9
a contatto obliquo, precaricati
e lubrificati con grasso a vita

INGRANAGGI GLEASON
garantiscono minor riscalda-
mento e rumorosità ed elevato
numero di giri

DOTAZIONE STANDARD

Valigetta / Stop block / Ghiera ER /
Chiavi di servizio /
Tubetto di grasso / Libro istruzioni

Vai alla pagina
di catalogo per
approfondire



ISO
CAT /
BT /**40**

**STOP BLOCK
INCLUSO**

STD 90°
SERIES



Ratio
1:1



Rpm
5.000



ISO / BT 40
Kg 7
ISO / BT 50
Kg 12



ER32
Ø2/20

EVOLUTION LINE ATC

F90-20S

Prezzo Listino ~~€ 3.749~~
Prezzo Speciale: **€ 3.000**

CONI INTERCAMBIABILI
Coni intercambiabili per un utilizzo
su più centri di lavoro.
Una sola testa per più centri di lavoro

CORPO TESTA IN ACCIAIO
Corpo testa orientabile a 360° con pressu-
rizzazione interna. In acciaio trattato, mas-
sima rigidità e resistenza alla corrosione

DOTAZIONE STANDARD

Valigetta / Stop block / Ghiera ER /
Chiavi di servizio /
Tubetto di grasso / Libro istruzioni

Vai alla pagina
di catalogo per
approfondire



MOLTIPLICATORE DI GIRI



ISO / BT 40
Kg 6
ISO / BT 50
Kg 8,5

**STOP BLOCK
INCLUSO**

GSP
SERIES



Ratio
1:8



Rpm
24.000
output
3.000
input



Kw 8



Nm 9,5



ISO / BT 40
Kg 6
ISO / BT 50
Kg 8,5

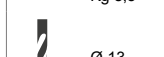

Ø 13



ER20
Ø1/13



N 413

EVOLUTION LINE

GSP 13

Prezzo Listino ~~€ 3.632~~
Prezzo Speciale: **€ 3.000**

ANCORA PIÙ VELOCI
Velocità aumentata
oltre il 30%
sull'intera gamma

REFRIGERAZIONE INTERNA
disponibile la refrigerazione interna su
tutta la gamma con pressione
fino a 70bar