

INSERTI PPU + VORTEX BAR

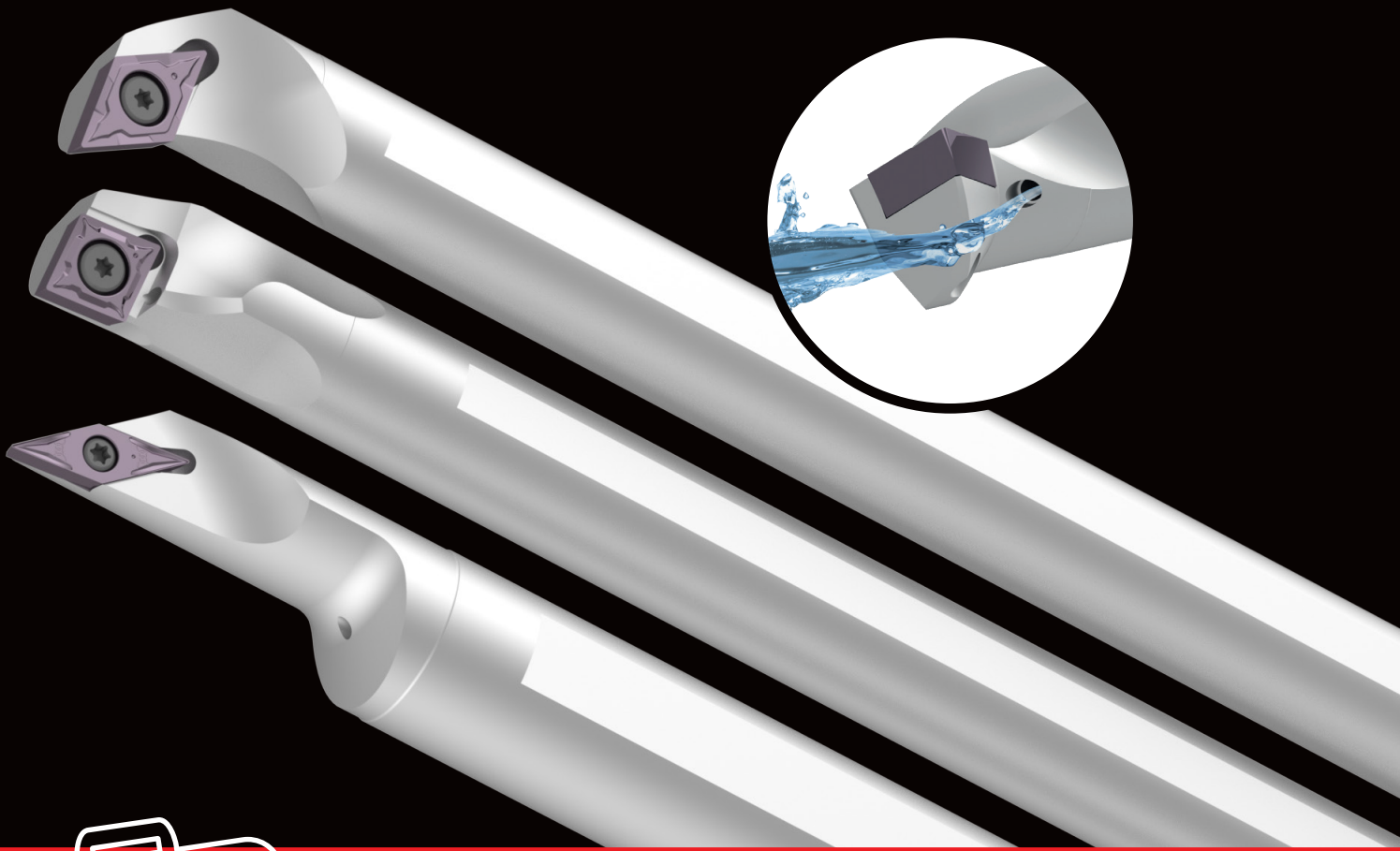

SPECIAL **KIT Action**

Inserti PPU con Vortex Bar
Kit per barenatura di precisione
(inclusa finitura con taglio interrotto
e barenatura pareti sottili)

nixkoTOOLS
SORMA CUTTING SOLUTIONS

uenme
TOOLS and EQUIPMENT

INSERTI PPU CON VORTEX BAR



nikkoTOOLS
SORMA CUTTING SOLUTIONS



**SPECIAL
KIT**



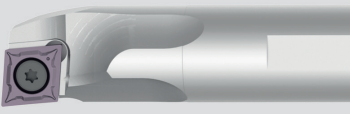

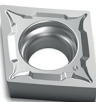

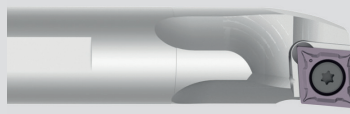

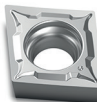

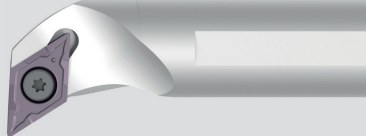
Prova Vortex Bar + inserti PPU!

Ogni kit contiene 4 Vortex Bar e 10 inserti PPU

R			
			DMIN
	1 x NT-V10K-SCLCR06-12 (Ø10)		12
	1 x NT-V12M-SCLCR06-14 (Ø12)	INTERNAL COOLANT	14
	1 x NT-V16Q-SCLCR09-18 (Ø16)		18
			22
		5 x CCGT060204-PPU 5 x CCGT09T304-PPU	JP5125 U-VORTEX-CC01R

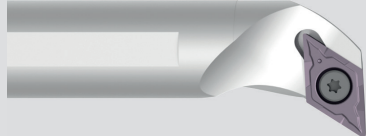
L			
			DMIN
	1 x NT-V10K-SCLCL06-12 (Ø10)		12
	1 x NT-V12M-SCLCL06-14 (Ø12)	INTERNAL COOLANT	14
	1 x NT-V16Q-SCLCL09-18 (Ø16)		18
			22
		5 x CCGT060204-PPU 5 x CCGT09T304-PPU	JP5125 U-VORTEX-CC01L

R			
			DMIN
	1 x NT-V10K-SDUCR07-14 (Ø10)		14
	1 x NT-V12M-SDUCR07-16 (Ø12)	INTERNAL COOLANT	16
	1 x NT-V16Q-SDUCR11-23 (Ø16)		23
			27
		5 x DCGT070204-PPU 5 x DCGT11T304-PPU	JP5125 U-VORTEX-DC01R

L			
			DMIN
	1 x NT-V10K-SDUCL07-14 (Ø10)		14
	1 x NT-V12M-SDUCL07-16 (Ø12)	INTERNAL COOLANT	16
	1 x NT-V16Q-SDUCL11-23 (Ø16)		23
			27
		5 x DCGT070204-PPU 5 x DCGT11T304-PPU	JP5125 U-VORTEX-DC01L





INSERTI PPU CON VORTEX BAR



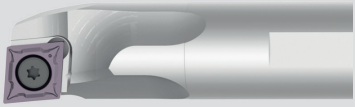

nikkoTOOLS
SORMA CUTTING SOLUTIONS





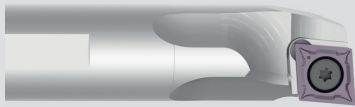

Prova Vortex Bar + inserti PPU!





Ogni kit contiene 3 Vortex Bar e 10 inserti PPU

R					
				DMIN	
1 x NT-V08H-SCLCR06-10 (Ø8)			INTERNAL COOLANT 	10	10
1 x NT-V10K-SCLCR06-12 (Ø10)		12		12	
1 x NT-V12M-SCLCR06-14 (Ø12)		14		14	
	10 x CCGT060204-PPU	JP5125		U-VORTEX-3CCR	

L					
				DMIN	
1 x NT-V08H-SCLCL06-10 (Ø8)			INTERNAL COOLANT 	10	10
1 x NT-V10K-SCLCL06-12 (Ø10)		12		12	
1 x NT-V12M-SCLCL06-14 (Ø12)		14		14	
	10 x CCGT060204-PPU	JP5125		U-VORTEX-3CCL	

Ogni kit contiene 2 Vortex Bar e 10 inserti PPU

R					
				DMIN	
1 x NT-V20R-SVJBR11-25 (Ø20)			INTERNAL COOLANT 	25	25
1 x NT-V25S-SVJBR11-30 (Ø25)		30		30	
	10 x VCGT110304-PPU	JP5125		U-VORTEX-VC01R	

L					
				DMIN	
1 x NT-V20R-SVJBL11-25 (Ø20)			INTERNAL COOLANT 	25	25
1 x NT-V25S-SVJBL11-30 (Ø25)		30		30	
	10 x VCGT110304-PPU	JP5125		U-VORTEX-VC01L	

Perché scegliere Vortex Bar?

- Migliora l'evacuazione del truciolo
- Riduce le vibrazioni anche ad elevate sporgenze (max 5xD)
- Canali di refrigerazione interna nell'intera gamma

Perché scegliere inserti PPU?

- Geometria con basse forze di taglio, affidabile, non deforma i pezzi e riduce le vibrazioni nelle operazioni di barenatura
- Grado resistente al calore, specifico per inox e super leghe, affidabilità costante
- Combinazione ottimizzata della geometria e del grado per affrontare molteplici sfide, come la barenatura interrotta interrotta di precisione di pareti sottili
- Soluzione universale, dalle lavorazioni più esigenti a quelle convenzionali

